

**VL**  
SERIES

# VL SERIES

VLA

VLF

VLS

VLI

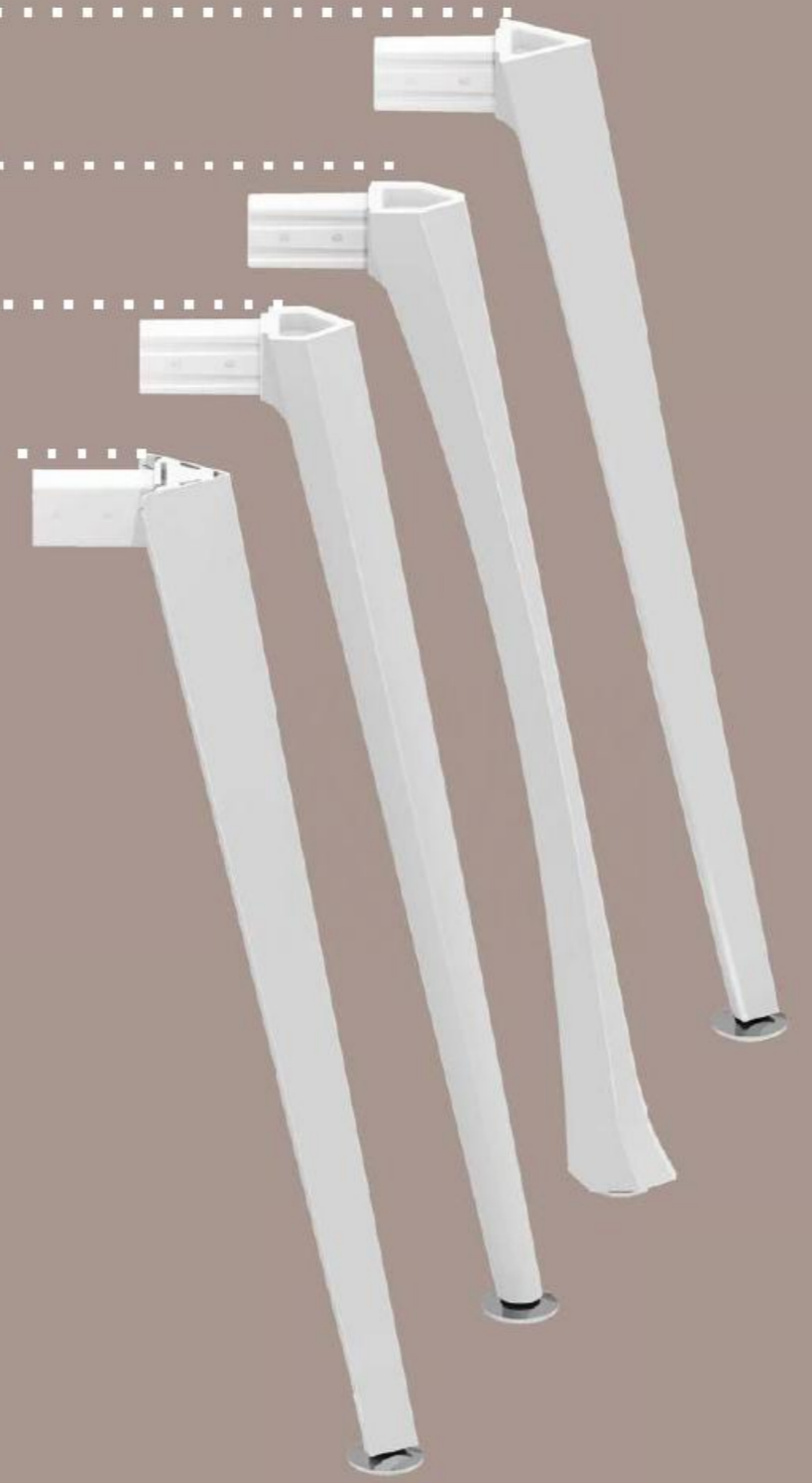

DESIGN CONCEPT

### 设计理念

VL系列是一款功能强大，组合多变的办公家具系统。其固定的台脚，多变的台脚，让你可以自由组合不同的造型。台脚表面采用镜面抛光，真正做到了环保与完美结合。布线简单，功能强大。悬浮式超薄桌上屏风，线条细腻、美观，打破了行业传统，让你轻松使用各种高精的办公设备。

VL features a high degree of functionality and variability. With more stability frame and more capacity legs, VL boasts more user-centric solutions than any desk before it. The bright mirror finishing legs are positioned for maximum effect, the end result is a one-of-a-kind sculpted beauty. Convenient wire system makes it easy to access different high-tech office equipment. VL is matching perfectly to our new table top panel that is so amazingly thin making it appear to float on air. Its natural appearance offers a distinction and simplicity that blends seamlessly with the age of technology. From the moment you unwrap our VL, you'll sense our passion and commitment to the art of creating desks with soul.



# VLA

CLOVER WORKSTATION

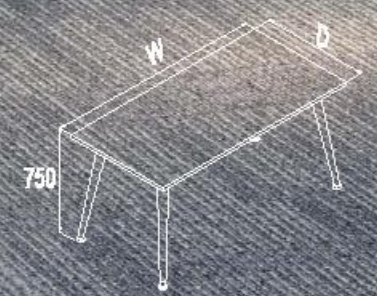

D (mm)	800	750	900	1000	1200		
W (mm)	1200	1400	1600	1800	2000	2200	2400

VLA-MG-B-MI

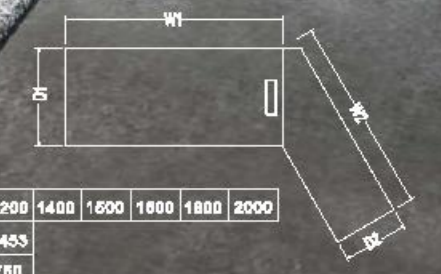

W1	1200	1400	1600	1800	1800	2000
W2	1453					
D1	760					
D2	600					

VLA-MG-L-MI 34

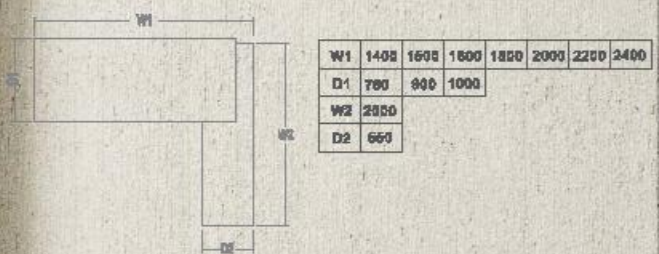

W1	1400	1600	1800	1820	2000	2200	2400
D1	780	900	1000				
W2	2050						
D2	660						

Wiedom le everywhere.  
智慧演绎 无所不在

VLA-MB-S-PC



D(mm)	800	800	800	800	800	760	750	760	760	750
W(mm)	1200	1400	1500	1600	1800	1200	1400	1500	1600	1800

VLA-W36-D 609

Concentration makes success 专注造就成功

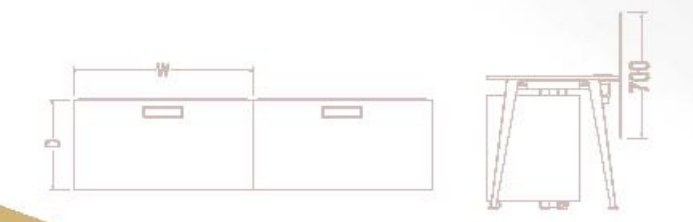

D(mm)	800	750
W(mm)	1200	1400 1500 1800 1800



D(mm)	1200	1500
W(mm)	8800	6300

Start your perfect journey.  
完美享受，由此触发



D(mm)	1200	1500	1200	1600	1200	1600	1200	1500
W(mm)	3000	3000	3800	3600	4200	4200	4600	4800



# V L F

CLOVER WORKSTATION

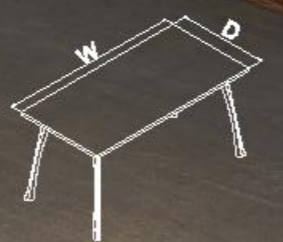

D(mm)	600	760	900	1000	1200		
W(mm)	1200	1400	1500	1800	2000	2200	2400

VLF-MG-B-MI

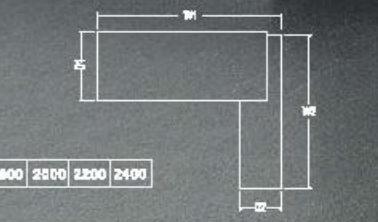

W1	1400	1800	1900	1800	2300	2300	2400
D1	750	900	1000				
W2	2000						
D2	850						

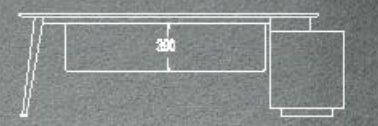

VLF-MG-S-MI 11/12



Where the work gets done, it is beautiful.  
匠心独运，美轮美奂。

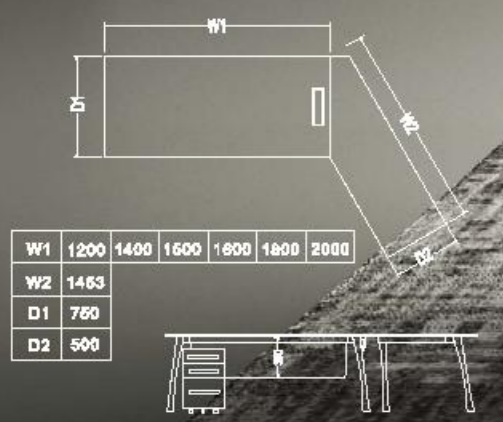

VLF-MC-L-MI



VL

25/28

VLF-W68-D 13/14





D(mm)	1200	1600
W(mm)	8300	8300

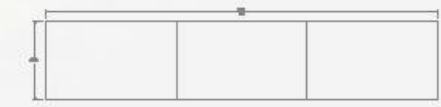

Design with Passion Makes a Desk with Soul.  
 大胆设计，“魂”成一体。

D(mm)	750	750	750	750	750	750	900	900	1000	1000	1200
W(mm)	1200	1400	1500	1800	1800	2000	1800	2000	2800	2400	2400



A round table, two soft chairs, let each other easy negotiation, pleasant exchange.  
一张圆桌，两张软椅，让彼此轻松谈判，愉快交流。

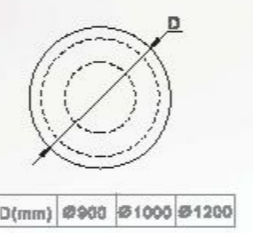
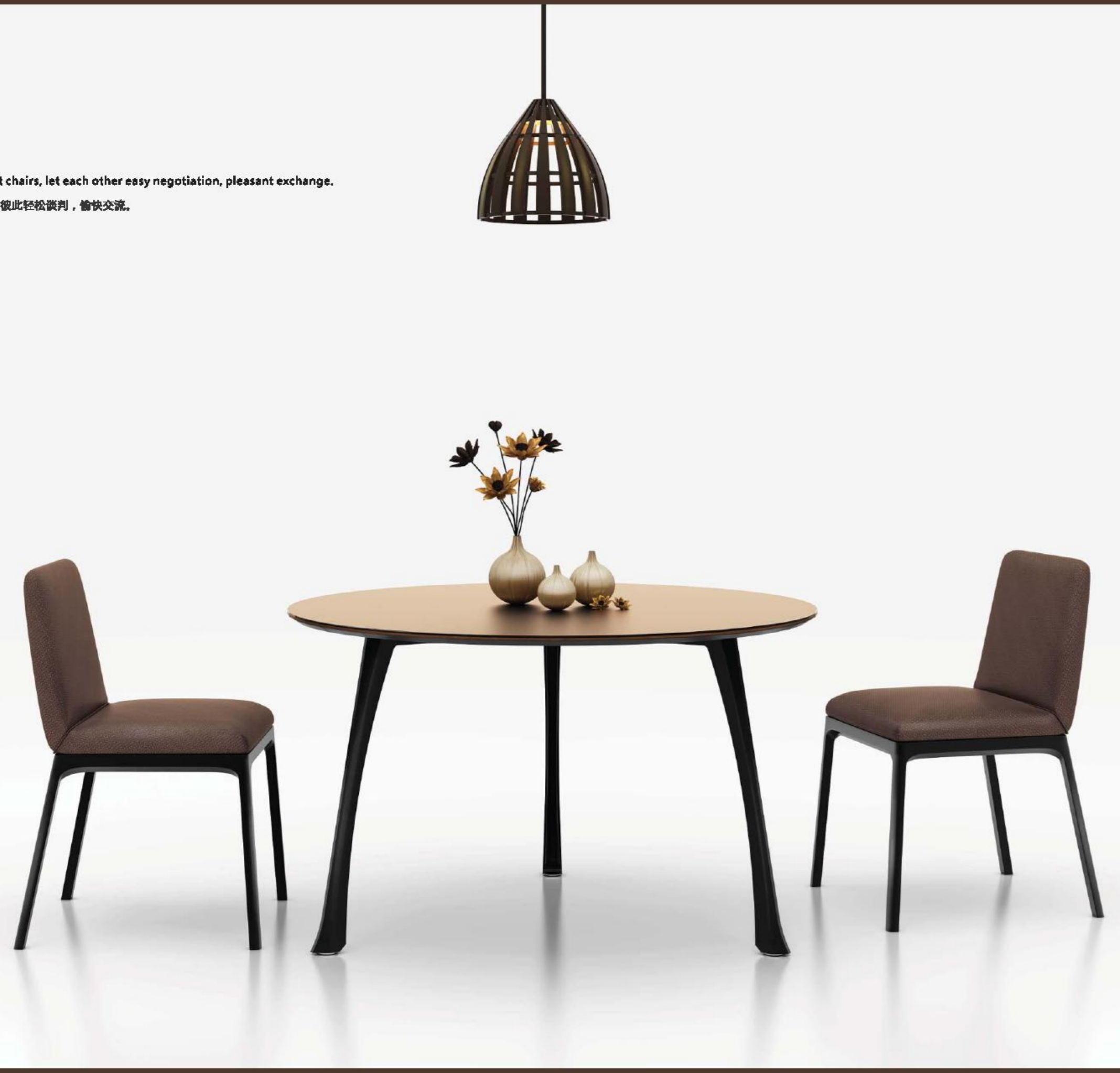

# V L S

GLOVER WORKSTATION



VLS-MG-B-MI



VL

VLS-MG-B-MI 18/20

Graceful colors and gentle material recapitulate the comfort and elegance of modern house to be a kind of simplicity and concinnity.  
典雅的色彩与温柔的质感，将现代办公的舒适与完美揉括成一种简洁、雅致。



D(mm)	600	750	800	1000	1200		
W(mm)	1200	1400	1600	1800	2000	2200	2400



VLS-MG-B-PC



D(mm)	800	600	800	800	800	760	700	750	780	760
W(mm)	1200	1400	1600	1600	1800	1200	1400	1500	1800	1800

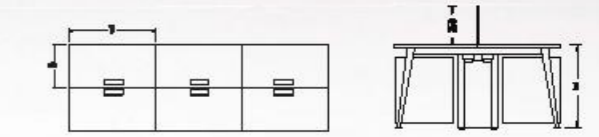

D(mm)	800	750			
W(mm)	1200	1400	1600	1800	1900

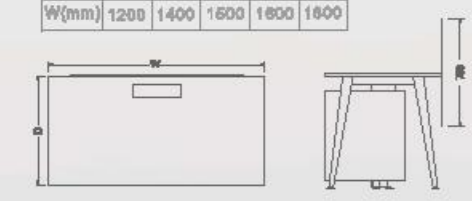

New Rhyme and stunningly beautiful coexist.  
 愉悦与美感无需取舍



D(mm)	1200	1600	1200	1500	1200	1600	1200	1600
W(mm)	2000	3000	3600	2800	4200	4200	4800	4800



VLI  
CLOVER WORKSTATION

New Design, More Precision.  
新的面貌，新的触动



D(mm)	900	800	600	800	600	750	750	750	750
W(mm)	1200	1400	1800	1800	1800	1200	1400	1800	1800



D(mm)	1200	1600
W(mm)	8300	8300





Flexible and adaptable design makes you lovin' it.  
 灵活多变，组合自用，让乐趣“坐”其中。

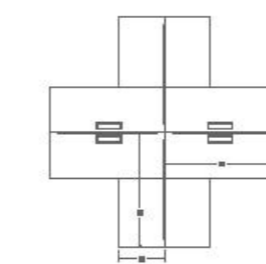

D1(mm)	600	800	600	800	600	750	750	750	750
W1(mm)	1200	1400	1500	1600	1800	1200	1400	1600	1800
D2(mm)	800	800	750	750					
W2(mm)	1200	1600	1200	1600					





# ROUND TABLE

CLOVER WORKSTATION



Great Design Sparks Emotion.  
灵感源于情感

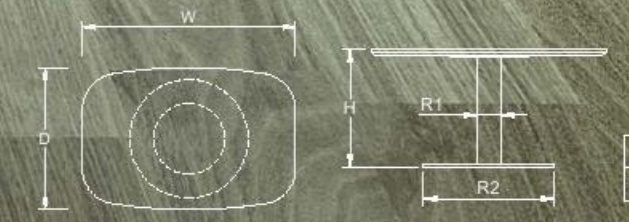

W	D	H	R1	R2
900	800	420	Ø88	Ø600

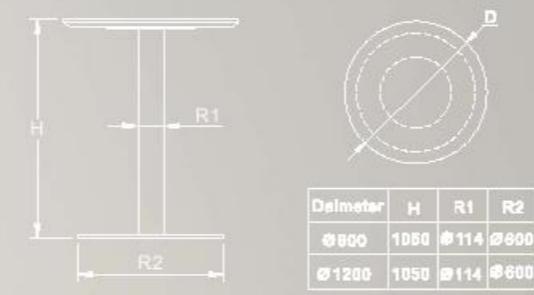

DYP-RT-H



Engineered for Maximum Workspace.  
空间远超想象

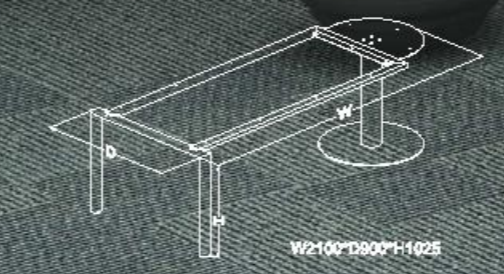

DYP-MT2412 33/34



# PROJECT ELEMENT

## 工程元素表

### Project Element 工程元素表

#### Code Explanation 编码说明

TB - St - 15 07 - B1 - PB - GY

Model 台面板编码前缀 - Shape 台面板类型 - Size 台面板规格 - Edge 封边类型 - Core 板芯 - Color 颜色类型

<b>TB:</b> Table top 桌面台面板	<b>Lt1:</b> L top-1 L型台面板-1	<b>W1:</b> Width1 宽1	<b>S:</b> Straight edge 直边	<b>PB:</b> Particle Board 颗粒板	<b>GY:</b> Grey color 灰白色
<b>GT:</b> Glass top 树脂玻璃台面板	<b>Lt3:</b> L top-3 L型台面板-3	<b>W2:</b> Width2 宽2	<b>B1:</b> 1 side bevel edge 1边切斜边 (短边)	<b>MB:</b> MDF Board 中纤板	<b>RW:</b> Regular wood grain 常规木纹色
	<b>St:</b> Straight top 直台面板	<b>D1:</b> Depth1 深1	<b>B2:</b> 2 side bevel edge 2边切斜边 (两长边)		<b>UW:</b> Unregular wood grain 非常规木纹色
	<b>Dt:</b> Round top 圆顶台面板	<b>D2:</b> Depth2 深2	<b>B3:</b> 3 side bevel edge 3边切斜边 (两长边+短边)		
	<b>Wt:</b> P top P型台面板		<b>B4:</b> 4 side bevel edge 4边切斜边		
	<b>Brt:</b> Return top 翻台面板				

TB - Lt1 - 15 12 06 05 - B1 - PB - GY

Model 台面板编码前缀 - Shape 台面板类型 - Size 台面板规格 - Edge 封边类型 - Core 板芯 - Color 颜色类型

<b>TB:</b> Table Top 桌面台面板	<b>Lt1:</b> L top-1 L型台面板-1	<b>W1:</b> Width1 宽1	<b>S:</b> Straight edge 直边	<b>PB:</b> Particle board 颗粒板	<b>GY:</b> Grey color 灰白色
<b>GT:</b> Glass Top 树脂玻璃台面板	<b>Lt3:</b> L top-3 L型台面板-3	<b>W2:</b> Width2 宽2	<b>B1:</b> 1 side bevel edge 1边切斜边 (短边)	<b>MB:</b> MDF board 中纤板	<b>RW:</b> Regular wood grain 常规木纹色
	<b>St:</b> Straight top 直台面板	<b>D1:</b> Depth1 深1	<b>B2:</b> 2 side bevel edge 2边切斜边 (两长边)		<b>UW:</b> Unregular wood grain 非常规木纹色
	<b>Dt:</b> Round top 圆顶台面板	<b>D2:</b> Depth2 深2	<b>B3:</b> 3 side bevel edge 3边切斜边 (两长边+短边)		
	<b>Wt:</b> P top P型台面板		<b>B4:</b> 4 side bevel edge 4边切斜边		
	<b>Brt:</b> Return top 翻台面板				

#### Shape 台面板类型

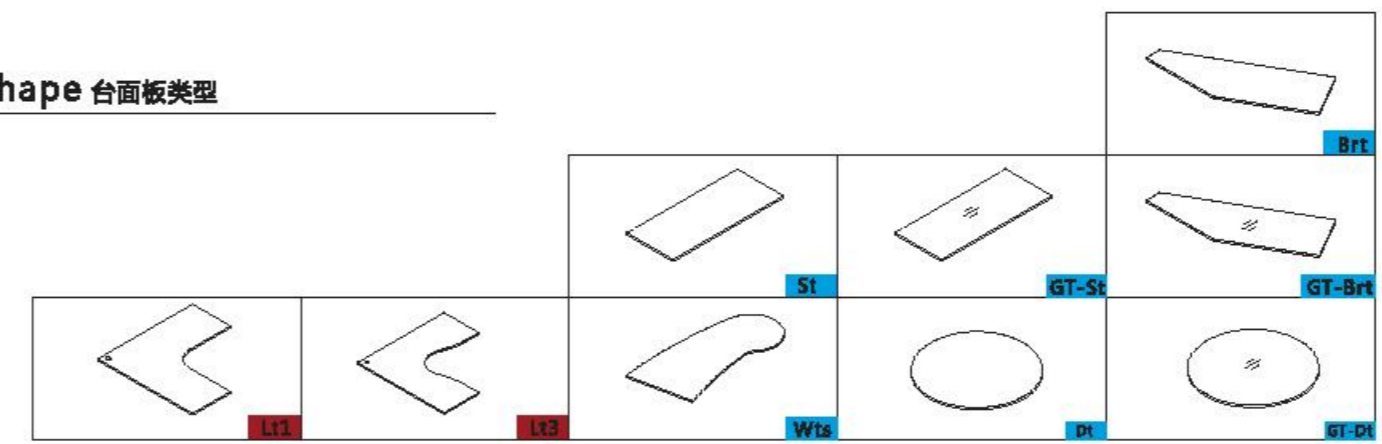

\* All L table top will be considered as customized because it need 5'x8' and 6'x8' board  
所有L型台面板属定制

#### Edge 封边类型

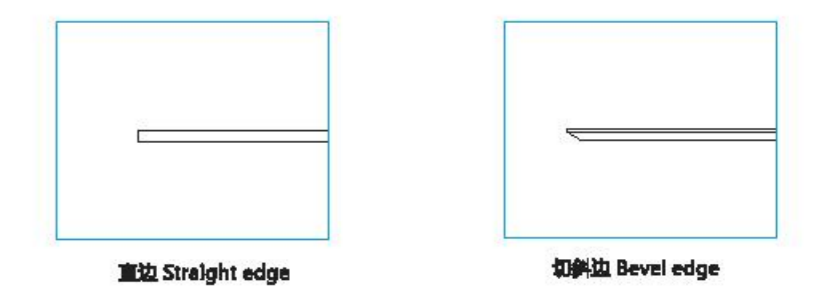

**CLOVER**  
WORKSTATION EXPERT

Typical configuration  
典型组合

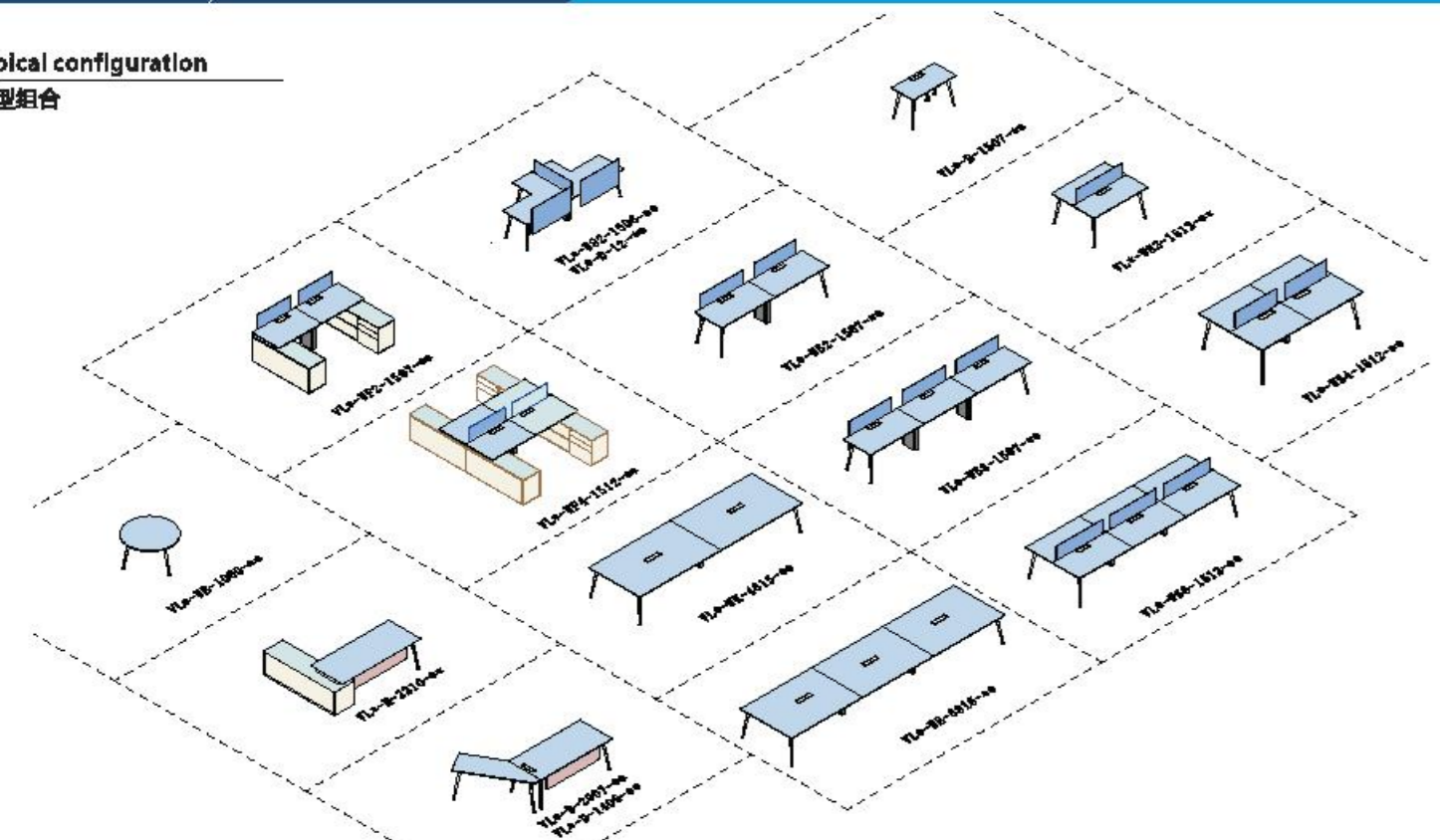

Wires system  
走线系统

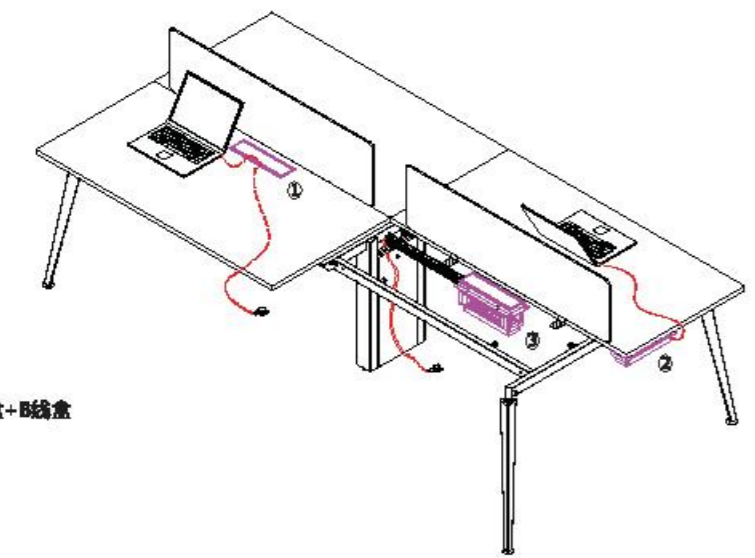

- ① A wires box A线盒
- ② B wires box B线盒
- ③ A wires box + B wires box A线盒+B线盒

Desk Frame Code Explanation  
台架编码说明

Complete Desk Frame Code  
完整台架编码

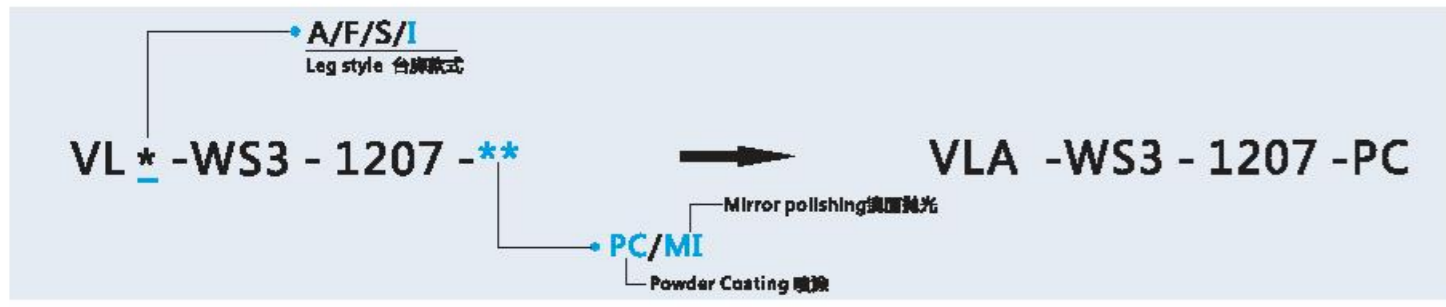

Project Element  
工程元素表





















Freestanding table frame 独立台架	Freestanding table frame 独立台架	2 Seats Desk frame 2位办公台架	3 Seats Desk frame 3位办公台架	2 Seats Bench table frame 2位办公台架	3 Seats Desk frame 3位办公台架
规格 Code VL-3-1207-**	规格 Code VL-3-1207-**	规格 Code VL-3-1207-**	规格 Code VL-3-1207-**	规格 Code VL-3-1207-**	规格 Code VL-3-1207-**
规格 Code VL-3-1207-**	规格 Code VL-3-1207-**	规格 Code VL-3-1207-**	规格 Code VL-3-1207-**	规格 Code VL-3-1207-**	规格 Code VL-3-1207-**
规格 Code VL-3-1207-**	规格 Code VL-3-1207-**	规格 Code VL-3-1207-**	规格 Code VL-3-1207-**	规格 Code VL-3-1207-**	规格 Code VL-3-1207-**
规格 Code VL-3-1207-**	规格 Code VL-3-1207-**	规格 Code VL-3-1207-**	规格 Code VL-3-1207-**	规格 Code VL-3-1207-**	规格 Code VL-3-1207-**
规格 Code VL-3-1207-**	规格 Code VL-3-1207-**	规格 Code VL-3-1207-**	规格 Code VL-3-1207-**	规格 Code VL-3-1207-**	规格 Code VL-3-1207-**

Element 元素表

Wood Swing Door Cabinet 木框门柜	Wood Swing Door Cabinet 木框门柜	Wood Swing Door Cabinet 木框门柜	Glass Swing Door Cabinet 玻璃门柜	Glass Swing Door Cabinet 玻璃门柜	Glass Swing Door Cabinet 玻璃门柜
规格 Code C-1207-3-W	规格 Code C-1207-3-W	规格 Code C-1207-3-W	规格 Code C-1207-3-G	规格 Code C-1207-3-G	规格 Code C-1207-3-G
规格 Code C-1207-3-W	规格 Code C-1207-3-W	规格 Code C-1207-3-W	规格 Code C-1207-3-G	规格 Code C-1207-3-G	规格 Code C-1207-3-G
规格 Code C-1207-3-W	规格 Code C-1207-3-W	规格 Code C-1207-3-W	规格 Code C-1207-3-G	规格 Code C-1207-3-G	规格 Code C-1207-3-G
规格 Code C-1207-3-W	规格 Code C-1207-3-W	规格 Code C-1207-3-W	规格 Code C-1207-3-G	规格 Code C-1207-3-G	规格 Code C-1207-3-G
规格 Code C-1207-3-W	规格 Code C-1207-3-W	规格 Code C-1207-3-W	规格 Code C-1207-3-G	规格 Code C-1207-3-G	规格 Code C-1207-3-G

Swing door cabinet with front level edge 前边齐平门柜	Swing door cabinet with front level edge 前边齐平门柜	Swing door cabinet with front level edge 前边齐平门柜	Open shelf cabinet with front level edge 前边齐平层架	Open shelf cabinet with front level edge 前边齐平层架	Open shelf cabinet with front level edge 前边齐平层架
规格 Code C-1207-3-W	规格 Code C-1207-3-W	规格 Code C-1207-3-W	规格 Code C-1207-3-S	规格 Code C-1207-3-S	规格 Code C-1207-3-S
规格 Code C-1207-3-W	规格 Code C-1207-3-W	规格 Code C-1207-3-W	规格 Code C-1207-3-S	规格 Code C-1207-3-S	规格 Code C-1207-3-S
规格 Code C-1207-3-W	规格 Code C-1207-3-W	规格 Code C-1207-3-W	规格 Code C-1207-3-S	规格 Code C-1207-3-S	规格 Code C-1207-3-S
规格 Code C-1207-3-W	规格 Code C-1207-3-W	规格 Code C-1207-3-W	规格 Code C-1207-3-S	规格 Code C-1207-3-S	规格 Code C-1207-3-S
规格 Code C-1207-3-W	规格 Code C-1207-3-W	规格 Code C-1207-3-W	规格 Code C-1207-3-S	规格 Code C-1207-3-S	规格 Code C-1207-3-S

Common Components 通用配件

<p><b>便條紙架 Note Tray</b></p>  <p>編碼 ( Code ) 規格 ( Size ) XDG-01 H60*W230*D320</p>	<p><b>電話托 Telephone Tray</b></p>  <p>編碼 ( Code ) 規格 ( Size ) XDG-02 H100*W220*D220</p>	<p><b>文件托架 Document Tray</b></p>  <p>編碼 ( Code ) 規格 ( Size ) XDG-03 H230*W160*D240</p>	<p><b>鉛筆筒 Pencil Tray</b></p>  <p>編碼 ( Code ) 規格 ( Size ) XDG-14 H120*W70*D70</p>
<p><b>主機架 CPU Holder</b></p>  <p>編碼 ( Code ) 規格 ( Size ) XDG-15 H380*W350*D300</p>	<p><b>疊加便條紙架 Superimposed doc trays</b></p>  <p>編碼 ( Code ) 規格 ( Size ) XDG-19A H155*W25*D855</p>	<p><b>便條紙架 Doc hang-tray</b></p>  <p>編碼 ( Code ) 規格 ( Size ) XDG-20 H50*W335*D250</p>	<p><b>多功能紙架 Multifunctional hang-tray</b></p>  <p>編碼 ( Code ) 規格 ( Size ) XDG-21 H35*W360*D145</p>
<p><b>文件托架 File hang-tray</b></p>  <p>編碼 ( Code ) 規格 ( Size ) XDG-24 H310*W160*D255</p>	<p><b>筆筒 Pencil hang-tray</b></p>  <p>編碼 ( Code ) 規格 ( Size ) XDG-25 H95*W93*D90</p>	<p><b>膠地線槽 Plastic snake</b></p>  <p>編碼 ( Code ) 規格 ( Size ) XDG-26 ∅60/H725</p>	<p><b>膠地線槽 Plastic snake</b></p>  <p>編碼 ( Code ) 規格 ( Size ) XD-ZDKC H725</p>
<p><b>鋼單抽 Metal single drawer</b></p>  <p>編碼 ( Code ) 規格 ( Size ) XD-MDC H80/126*W309*D327</p>	<p><b>紙托架 Paper keeper</b></p>  <p>編碼 ( Code ) 規格 ( Size ) XD-PK080 H56*W800*D12</p>	<p><b>A線盒 A wires box</b></p>  <p>編碼 ( Code ) 規格 ( Size ) XD-AXH H29*W326*D99</p>	<p><b>B線盒 B wires box</b></p>  <p>編碼 ( Code ) 規格 ( Size ) XD-BXH H97*W343*D114</p>
<p><b>吊主機架 Hanging cpu holder</b></p>  <p>編碼 ( Code ) 規格 ( Size ) XD-DZJJ \</p>	<p><b>外置托架 External Rail</b></p>  <p>編碼 ( Code ) 規格 ( Size ) VL-EAC08 W300*D14*H14</p>	<p><b>SBD全網櫃架 Metal pedestal</b></p>  <p>編碼 ( Code ) 規格 ( Size ) PD-T-BBF W400*D520*H630</p>	<p><b>薄邊二抽活動櫃架 Thin edge pedestal</b></p>  <p>編碼 ( Code ) 規格 ( Size ) PD-T-BF W400*D520*H490</p>



STOCK ELEMENT  
倉存元素表

VL series

Stock Elements 倉存元素表











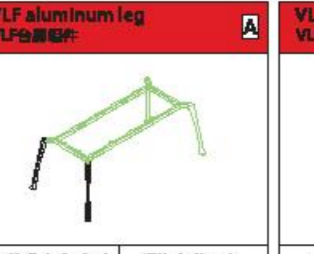
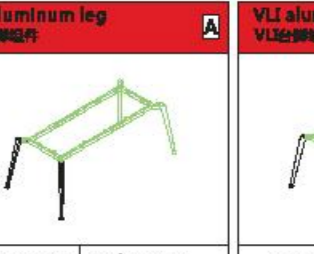
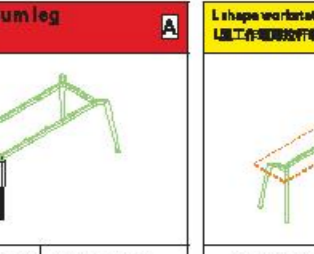

<p><b>VLA aluminum leg VLA台腳組件</b></p>  <p>編碼 ( Code ) 規格 ( Size ) VLA-PC H725 VLA-81 H725</p>	<p><b>VLF aluminum leg VLF台腳組件</b></p>  <p>編碼 ( Code ) 規格 ( Size ) VLF-PC H725 VLF-81 H725</p>	<p><b>VLS aluminum leg VLS台腳組件</b></p>  <p>編碼 ( Code ) 規格 ( Size ) VLS-PC H725 VLS-81 H725</p>	<p><b>VLI aluminum leg VLI台腳組件</b></p>  <p>編碼 ( Code ) 規格 ( Size ) VLI-PC H725</p>	<p><b>L shape workstation return table bar L型台腳組件</b></p>  <p>編碼 ( Code ) 規格 ( Size ) VL-DEB H1200-1500</p>
<p><b>Side to side bar 兩行加闊中橫杆組件</b></p>  <p>編碼 ( Code ) 規格 ( Size ) VL-SB-1800 H790 VL-SB-1400 H790 VL-SB-1600 H790 VL-SB-1800 H790 VL-SB-1800 H790 VL-SB-2000 H790 VL-SB-2200 H790 VL-SB-2400 H790</p>	<p><b>Side to Mid bar 兩行加闊中橫杆組件</b></p>  <p>編碼 ( Code ) 規格 ( Size ) VL-SB-1800 H960 VL-SB-1400 H960 VL-SB-1600 H960 VL-SB-1800 H960 VL-SB-1800 H960 VL-SB-2000 H960 VL-SB-2200 H960 VL-SB-2400 H960</p>	<p><b>Mid to Mid bar 兩行中間中橫杆組件</b></p>  <p>編碼 ( Code ) 規格 ( Size ) VL-MB-1800 H1180 VL-MB-1400 H1180 VL-MB-1600 H1180 VL-MB-1800 H1180 VL-MB-1800 H1180 VL-MB-2000 H1180 VL-MB-2200 H1180 VL-MB-2400 H1180</p>	<p><b>Freestanding extension bar 0-200 adjustable 獨立伸縮中橫杆組件</b></p>  <p>編碼 ( Code ) 規格 ( Size ) VL-FEB-200 W550</p>	<p><b>Branch extension bar 0-200 adjustable 分支伸縮中橫杆組件</b></p>  <p>編碼 ( Code ) 規格 ( Size ) VL-BCB-200 W890</p>
<p><b>Leg frame (single bar) 腳架組件</b></p>  <p>編碼 ( Code ) 規格 ( Size ) VL-LJ-0600 H284*D170*H80 VL-LJ-0700 H484*D170*H80</p>	<p><b>Leg frame (double bar) 腳架組件</b></p>  <p>編碼 ( Code ) 規格 ( Size ) VL-LJ-0750 H474*D170*H80 VL-LJ-0850 H484*D170*H80 VL-LJ-1000 H784*D170*H80</p>	<p><b>Leg frame (bench) 腳架組件</b></p>  <p>編碼 ( Code ) 規格 ( Size ) VL-LJ-1800 H684*D170*H80 VL-LJ-1800 H1284*D170*H80</p>	<p><b>Leg frame (return) 腳架組件</b></p>  <p>編碼 ( Code ) 規格 ( Size ) VL-LJ-1400 H1087*D114*H80</p>	<p><b>Round table frame 圓台腳架組件</b></p>  <p>編碼 ( Code ) 規格 ( Size ) VL-EJ-1800 ∅200*H260 VL-EJ-1800 ∅200*H320 VL-EJ-0800 ∅200*H260</p>
<p><b>Side cabinet small leg 側櫃支撐腳組件</b></p>  <p>編碼 ( Code ) 規格 ( Size ) VL-SGL-0207 H160*H30*H190</p>	<p><b>Side cabinet bevel wire box 側櫃支撐線盒組件</b></p>  <p>編碼 ( Code ) 規格 ( Size ) VL-SGL-0300 H300*H300*H200 VL-SGL-0300 H300*H300*H300</p>	<p><b>Mid leg 兩行聯合中橫杆組件</b></p>  <p>編碼 ( Code ) 規格 ( Size ) VL-ML-0800 H420*H320*H725</p>	<p><b>Mid leg 兩行聯合中橫杆組件</b></p>  <p>編碼 ( Code ) 規格 ( Size ) VL-ML-0750 H420*H320*H725</p>	<p><b>Mid leg 兩行聯合中橫杆組件</b></p>  <p>編碼 ( Code ) 規格 ( Size ) VL-ML-1800 H600*H320*H725 VL-ML-1400 H4100*H320*H725 VL-ML-1800 H1300*H320*H725</p>

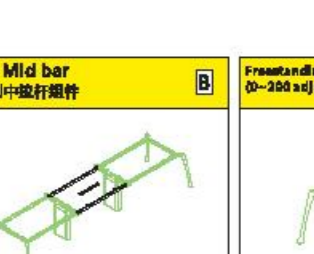
Table with 5 columns: L shape table top (L形台面), Straight table top with bevel edge (直边台面), Open shelf cabinet with front bevel edge (侧边空架柜), Side cabinet A with bevel edge (侧边台柜A), Side cabinet B with bevel edge (侧边台柜B).

Table with 5 columns: Straight table top with bevel edge (直边台面), Round table top (圆形台面), Side cabinet D with bevel edge (侧边台柜D), Side cabinet E with bevel edge (侧边台柜E), Wood Credenza (餐边柜), Bare Case Cabinet (柜架), Side cabinet GM with bevel edge (侧边台柜GM).

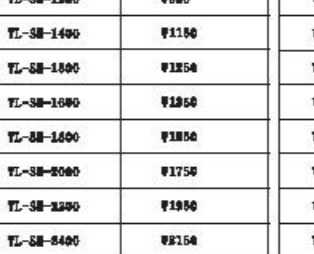
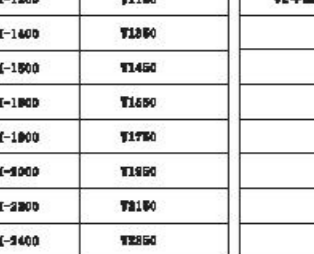
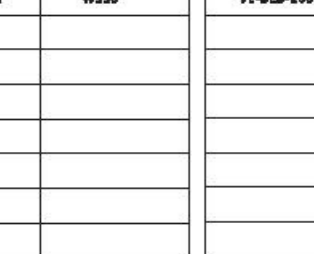
Table with 5 columns: Return table top (回形台面), Curved table top (P形台面), Glass table top (玻璃台面), Thin edge pedestal (薄边柜脚), Thin edge pedestal (薄边柜脚), Metal single drawer (小抽屜), Glass desk screen (玻璃桌上屏).

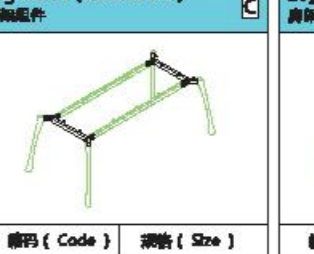
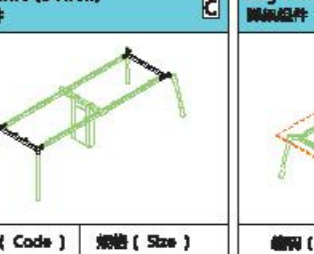
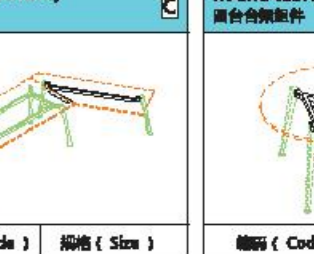
Table with 5 columns: Glass table top (玻璃台面), Swing door cabinet with front bevel edge (侧边门柜), Swing door cabinet with front bevel edge (侧边门柜), Swing door cabinet with front bevel edge (侧边门柜), Swing door cabinet with front bevel edge (侧边门柜).

Table with 5 columns: Open shelf cabinet with front bevel edge (侧边空架柜), Side cabinet A with bevel edge (侧边台柜A), Side cabinet B with bevel edge (侧边台柜B), Side cabinet D with bevel edge (侧边台柜D), Side cabinet E with bevel edge (侧边台柜E), Wood Credenza (餐边柜), Bare Case Cabinet (柜架), Side cabinet GM with bevel edge (侧边台柜GM).

Table with 5 columns: Thin edge pedestal (薄边柜脚), Thin edge pedestal (薄边柜脚), Metal single drawer (小抽屜), Glass desk screen (玻璃桌上屏), Wood Modesty Panel (木隔板), Fabric desk screen (布艺桌上屏), Fabric desk screen (布艺桌上屏), Paper keeper (按纸器).

Table with 5 columns: Glass desk screen (玻璃桌上屏), Wood Modesty Panel (木隔板), Fabric desk screen (布艺桌上屏), Fabric desk screen (布艺桌上屏), Paper keeper (按纸器).

Table with 5 columns: Glass desk screen (玻璃桌上屏), Wood Modesty Panel (木隔板), Fabric desk screen (布艺桌上屏), Fabric desk screen (布艺桌上屏), Paper keeper (按纸器).

Table with 10 columns: Start cable (启动线), Middle Socket (插座), End Socket (插座), A wire box (A线盒), B wire box (B线盒), Wood Modesty Panel bracket (木隔板托臂), Fabric desk screen bracket (布艺桌上屏托臂), Fabric desk screen bracket (布艺桌上屏托臂), Glass desk screen bracket for double (玻璃桌上屏托臂), Glass desk screen bracket for double (玻璃桌上屏托臂).

Table with 6 columns: Note tray (便条盒), Telephone tray (电话托), Document tray (文件托架), Pencil tray (笔筒), CPU holder (电脑主机架), Hanging CPU holder (吊挂式主机架).

Table with 5 columns: Superimposed doc trays 2 (叠放式文件架), Doc hang-tray (文件托架), Multifunctional hang-tray (多功能挂架), Hang-vase (花瓶架), Photo frame (相框).



Table with 5 columns: File hang-tray (文件托架), Pencil hang-tray (笔筒), Plastic snake (塑料蛇形), Plastic snake (塑料蛇形), Keel tray (龙骨托架).



Table with 5 columns: Cushion (垫脚), Cabinets Leg-Side (文件柜底座-侧边), Cabinets Leg-Mid (文件柜底座-中间), Cabinets Leg H90 (加厚型脚脚), Cabinets Leg (脚架).



MATERIAL ELEMENT

材质元素表

Material Element 材质元素表

Small pear 小梨纹系列

									
15-44	15-01	15-02	15-03	15-21	15-103	15-55	15-75	15-105	15-106
									
15-04	15-05	15-06	15-07	15-08	15-101	15-102	15-04	15-107	15-108
									
15-09	15-10	15-11	15-12	15-13	15-109	15-110	15-111	15-118	15-119
									
15-14	15-15	15-16	15-17	15-18	15-153	15-155	15-158	15-161	15-184
									
15-19	15-20	15-41	15-48	15-49	15-161	15-171	15-173	15-175	15-184

**Metal 金属**

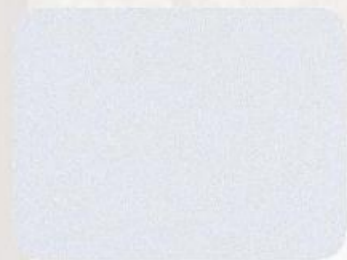

UTOR-14(sanding white)



UTOR-16(sanding black)



F1(anodize)



Mirror polishing

**Wood 木板**

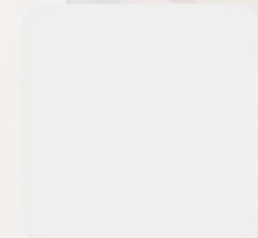

XD-1009(white)



XD-1001(grey)



XD-1004(black)



XD-1008(mini-maple)



XD-1028(oak relieve)



XD-1014(teak)



XD-1016(walnut)



XD-1019(white maple)



XD-1020(maple)



XD-1021(fir)

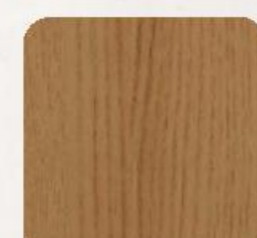

XD-1022(red oak relieve)



XD-1023(white oak relieve)



XD-1024(technology oak)



XD-1025(black oak relieve)

VL  
SERIES